

Safety **1st**[®]

onBoard™ 35

4-35 pounds (1.8-15.9kg), 32 inches (81.2 cm) or less



See our full line of crash tested accessories at
www.safety1st.com

Safety **1st**[®]

**KEEP INSTRUCTIONS
FOR FUTURE USE.**

Read all instructions before
using this child restraint.



4358-4805B



© 2010 Dorel Juvenile Group All Rights Reserved.

⚠ WARNING:

**Failure to follow the warnings on the labels and
in the instruction manual can result in serious
injury or death to your child.**

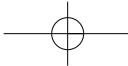

A. Before You BeginPages 3-8

- A-1 Thank You...
- A-2 Registration and Safety Notices
- A-3 Understanding Your Child Restraint

D. General Vehicle Installation ...Pages 31-38

- D-1 Understanding Your Vehicle
- D-2 Vehicle Seating Position
- D-3 Choosing LATCH or Vehicle Belts
- D-4 Knowing Your Vehicle Belts
- D-5 Using Locking Clip
- D-6 Installing on Aircraft
- D-7 Storing LATCH System

B. Safety InformationPages 9-10

- B-1 Vehicle Seating Position
- B-2 Installation in Vehicle
- B-3 Child Restraint Use

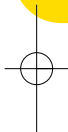

C. Basic UsePages 11-30

- C-1 Remove and Install the Carrier to Base
- C-2 Reclining the Base
- C-3 Carrier Use
- C-4 Child Restraint Use
- C-5 Preparing Child Restraint to Fit Your Child
- C-6 Securing Child in Child Restraint
- C-7 Remove Child from Child Restraint
- C-8 Removing Harness System
- C-9 Removing Pad for Cleaning
- C-10 Canopy Use and Installation
- C-11 Infant Insert
- C-12 Installing Harness System

E. Installing Rear-FacingPages 39-48

E-1 Rear-Facing Installation with Base

E-2 Preparing to Install Base with LATCH

E-3 Installing Base with LATCH



E-4 Installing Base with Vehicle Belts



E-5 Rear-Facing Installation without Base

E-6 Installing Carrier with Vehicle Belts

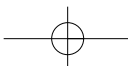

A-1 Thank You...

Thank you for choosing this car seat, referred to throughout this manual as a child restraint. The DJG family is committed to creating a child restraint with the most comfort and convenience available today.

Remember, parents are a child's first teachers and examples. If you always buckle your seat belt, your child will think it is the natural thing to do. Make it a firm rule that the vehicle does not go until everyone is buckled up. Make no exceptions.

No one can predict if use of a child restraint will prevent injury or death in a particular crash. However, combined with careful driving, proper use of a child restraint can lower a child's risk of injury or death in most crashes.

Your child's safety is worth the time it will take to read and follow these instructions. After reading, if you still have questions or have any problems with this child restraint, please contact our Consumer Relations Department at:

Dorel Juvenile Group, Inc.

Website: www.djgusa.com
 Fax: 1-800-207-8182
 Mailing Address: Dorel Juvenile Group, Inc.
 P.O. Box 2609
 Columbus, IN 47202-2609
 Telephone: 1-800-544-1108
 7 A.M. to 6 P.M. EST M-TH
 7 A.M. to 4:30 P.M. EST FRI

On the back of the plastic shell there is an expiration date for use of this child restraint. Do not use this child restraint after the expiration date.

Para recibir las instrucciones en español, llame al 1-800-544-1108 o solicítase por escrito al dirección por arriba.

A-2 Registration and Safety Notices

Please complete the postage-paid registration card that came with your child restraint, and send it to us. Child restraints could be recalled for safety reasons. You must register this restraint to be reached in a recall. Send your name, address, email address if available, and the restraint's model number and manufacturing date to:

Dorel Juvenile Group, Inc.
 PO Box 2609, Columbus, IN 47202-2609
 Attn: Consumer Relations

or call 1-800-544-1108 or register online at www.djgusa.com/registration/carseat/us.

For recall information, call the U.S. Government's Vehicle Safety Hotline at 1-888-327-4236 (TTY: 1-800-424-9153), or go to <http://www.NHTSA.gov>

A. Before You Begin

Consumer: Just fill in your name, address and email. Please print (use dark ink).

Name _____

Street Address _____

City _____ State _____ Zip Code _____

Email Address (optional) _____

BC027-ASW SE 1 BOOST AIR PROTECT 08/05/2010

P522 B 051950

If you don't have the card or if your address changes, you will find the model number and manufactured date on the label located on side of plastic shell.

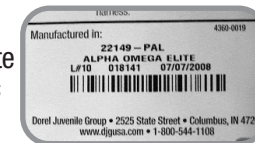

A-3 Understanding Your Child Restraint

Front View

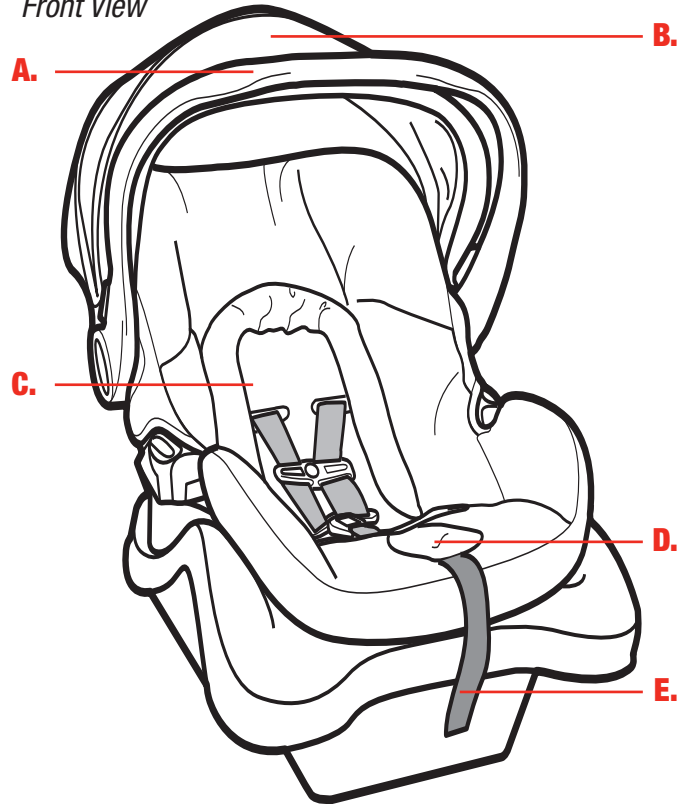

- A. Carry Handle**
- B. Canopy**
- C. Head/Hip Roll**
(on select models)
- D. Harness Release Lever** (under flap)
- E. Harness Tightening Strap**

5

Back View

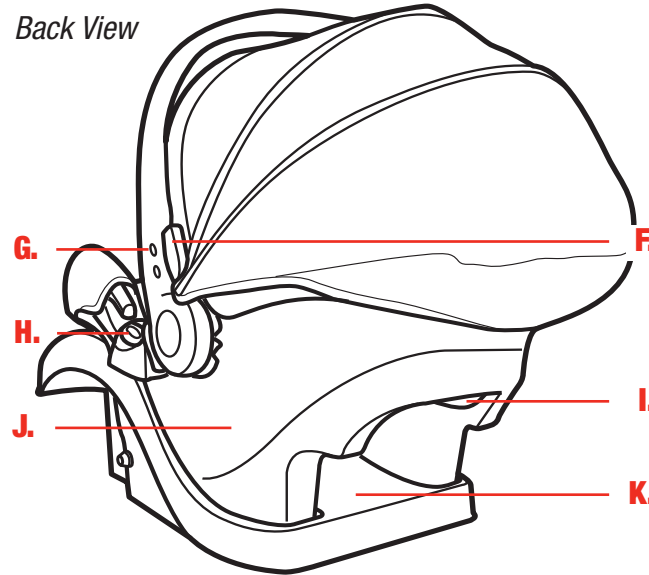

- F. Handle Adjustment Lever**
- G. Handle Lock Indicator**
- H. Angle Indicator**
- I. Base Release Handle**
- J. Carrier** (shell)
- K. Removable Base**

A. Before You Begin

Harness System Detail

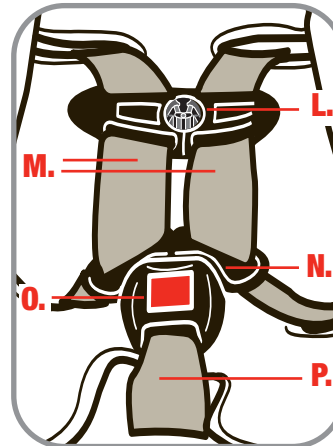

- L. Chest Clip**
- M. Harness Straps**
- N. Buckle Tongue**
- O. Buckle**
- P. Buckle Strap**

6

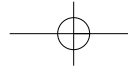

Bottom of Carrier

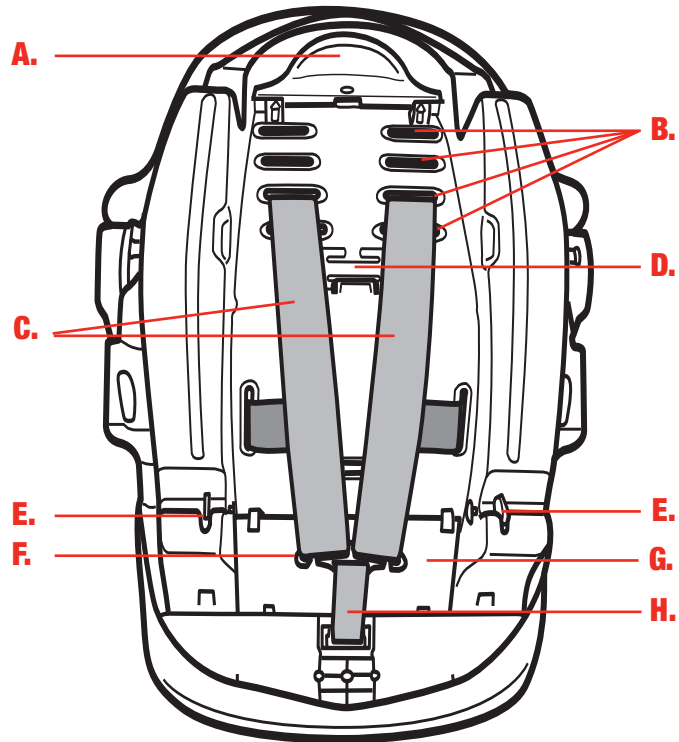

- A. Base Release Lever**
- B. Harness Slots**
- C. Harness Straps**
- D. Locking Clip**
- E. Base Attachment Hooks**
- F. Splitter Plate**
- G. Instruction Book Storage**
- H. Harness Tightening Strap**

Top of Base

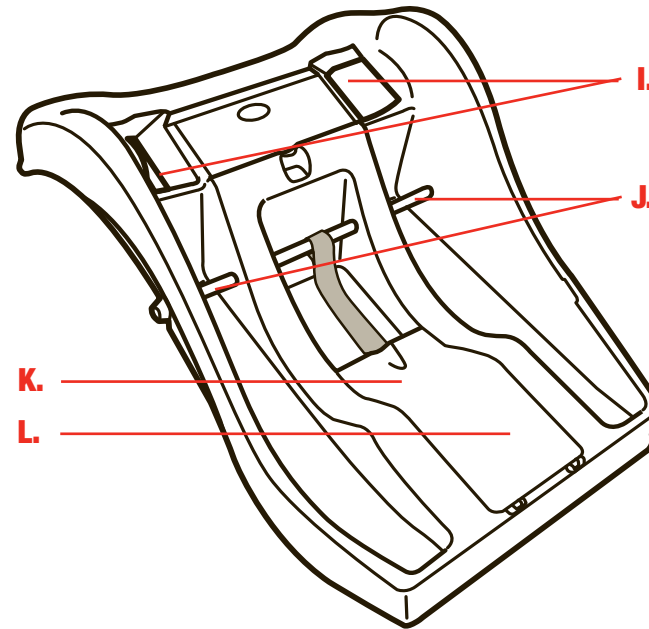

- I. Base Belt Path Openings**
- J. Base/Carrier Lock Bar**
- K. LATCH Storage Door**
- L. LATCH Belt (under storage door)**

A. Before You Begin

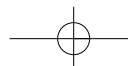
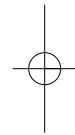
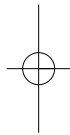

⚠ WARNING:

Failure to follow these warnings can result in the serious injury or death of your child. To help you recognize instructions which are most critical to your child's safety, we use this symbol: ⚠

B-1 Vehicle Seating Position



⚠ Never place a child rear-facing in a seating position with an active frontal airbag.

⚠ Check the vehicle owner's manual for more information about air bag/child restraint use.

⚠ For vehicles without a back seat, refer to your vehicle owner's manual.

B-2 Installation in Vehicle

⚠ Check the vehicle belt or LATCH belt before each use. Use only if the belt is tightened properly and securely.

⚠ This child restraint should be securely belted in the vehicle even when not in use. In a crash or sudden stop, an unsecured child restraint could injure occupants.

⚠ Do not use a child restraint that has been in a crash. You must get a new child restraint.

B-3 Child Restraint Use

⚠ This child restraint must only be used when the child weighs between 4-35 lbs. (1.8-15.9 kg).

⚠ Never take your child out of the child restraint while the vehicle is moving. Never leave child unattended.

⚠ Placing your child in a hot child restraint may result in burns.

⚠ Do not use a child restraint with damaged or missing parts.

⚠ Do not use cut, frayed or damaged harnesses.

⚠ Do not lubricate buckles and fasteners.

⚠ Do not substitute parts or try to modify the child restraint in any way.

⚠ Do not use any child restraint accessory except those approved by Dorel Juvenile Group.

⚠ Never allow any child to play with this child restraint; it is not a toy.

⚠ Do not remove or cover up any of the warning labels or other labels on the child restraint.

⚠ Read all instructions for additional warnings.

G-1 Remove and Install the Carrier to Base

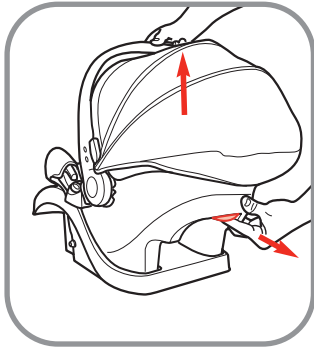

To Remove Carrier from Base

From the back of the carrier, pull the base release handle out and lift the carrier out of the base.

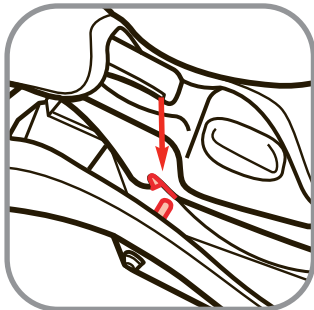

To Attach Carrier to Base

Align the notches in the front of carrier with the base lock bar. Push down firmly to lock. You will hear a "click" when it is locked. Pull up on carrier to make sure it is locked.

⚠ WARNING:
Failure to securely attach carrier to base can result in serious injury or death.

G-2 Reclining the Base (on select models)

Depending on your model, the base may have 2 recline positions. Use any of these to help you achieve the recline angle needed for the weight of your child.

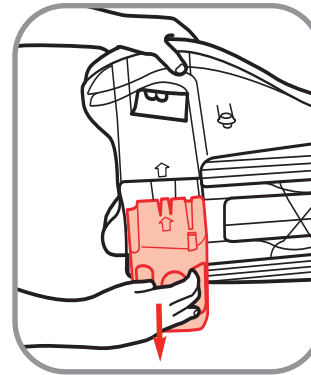

1. Pull Foot Out

From the bottom of the base, pull out the base foot.

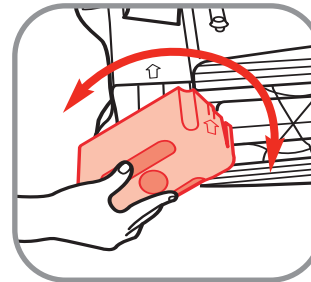

2. Rotate Foot

Rotate foot 1/2 way around.

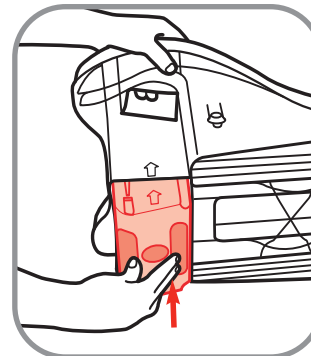

3. Align Arrows and Push Foot In

Push foot back inside the base. You will hear a "click" when foot is locked in.

G-3 Carrier Use

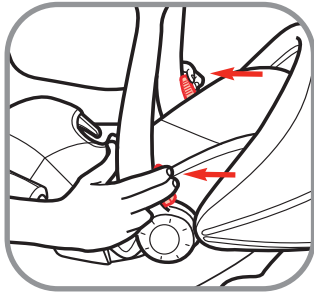

To Adjust Carrying Handle

Squeeze both adjustment levers on each side of handle. Rotate up or down to desired location. Release levers.

When the handle adjuster levers are in the locked position, the lock indicator will be green. Make sure both handle adjuster levers are in the locked position.

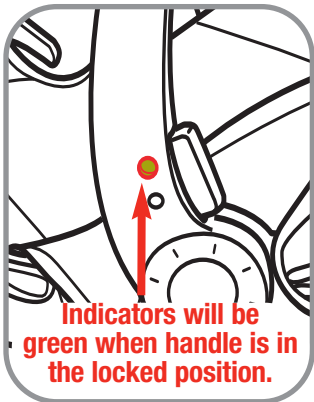

Indicators will be green when handle is in the locked position.

⚠ WARNING:



DO NOT use in the seating area or across the top of shopping carts.

⚠ WARNING:

Read ALL instructions before using child restraint as a carrier.

NEVER use carrier unless child is properly secured. For use as a carrier by children weighing less than 35 pounds (15.9 kg) and less than 32 inches (81.2 cm) tall.

NEVER leave child unattended. Always keep child within arm's reach.

Suffocation Hazard: Infant carrier can roll over on soft surfaces and suffocate child. **NEVER** place carrier on beds, sofas or other soft surfaces.

Strangulation Hazard: Child can strangle in loose harness straps. **NEVER** leave child in carrier when harness straps are loose or undone.

Fall Hazard: Child's movement can slide carrier. **NEVER** place carrier near edges of counter tops, tables or other elevated surfaces.

Do not use the carrier if it is damaged or broken, or if any parts are missing.

G-4 Child Restraint Use

This child restraint is to be used rear-facing with children weighing 4-35 lbs (1.8-15.9 kg) AND 32 inches (81.2 cm) tall or less.

NOTE: If your child does not meet the criteria for the Rear-Facing position, do not use this child restraint.

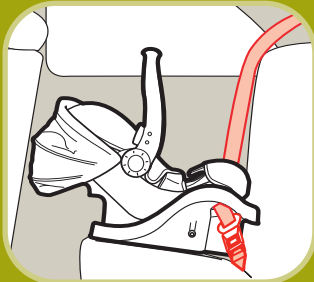

4-35 lbs (1.8-15.9 kg) and 32 inches (81.2 cm) tall or less

Rear-Facing with base: Child and child restraint with base face the back of the vehicle and are placed in the back seat.

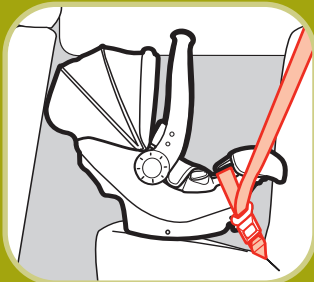

4-35 lbs (1.8-15.9 kg) and 32 inches (81.2 cm) tall or less

Rear-Facing without base: Child and child restraint without base face the back of the vehicle and are placed in the back seat.

G-5 Preparing Child Restraint to Fit Your Child

Make these adjustments with your child in the child restraint before you install in the vehicle.

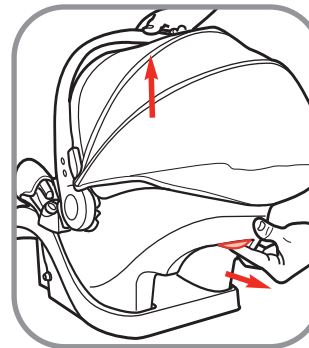

1. To Remove Carrier from Base

From the back of the carrier, pull the base release handle out and lift the carrier out of the base.

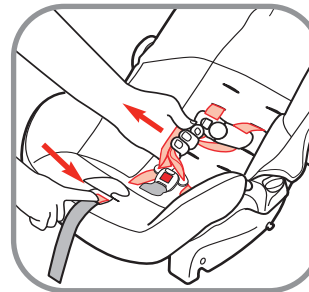

2. Loosen Harness

Push down on the harness release lever (under flap on the front of child restraint) while pulling out on both harness straps.

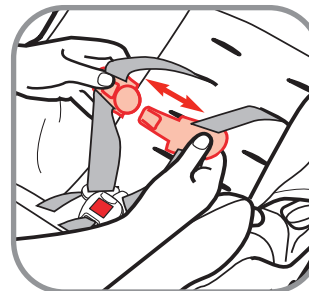

3. Release Chest Clip

Press on chest clip release button and pull apart.

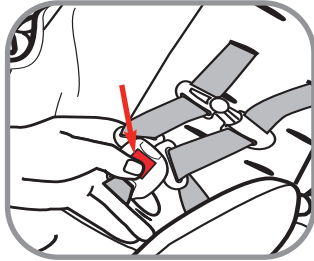

4. Unbuckle Harness
Press red button. Pull buckle tongues out. Place harness straps over sides of child restraint.

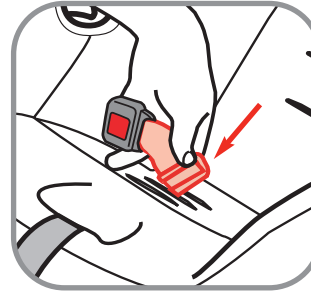

b. Choose new location and push the metal clip through pad and carrier. Make sure the buckle is facing out.



5. Place Child in Child Restraint
Place the child's bottom and back flat against the child restraint. This will increase comfort and allow the harness straps to be properly tightened.

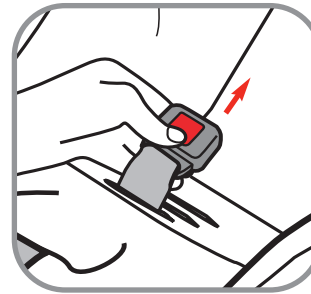

c. Pull on the buckle to check to make sure buckle's metal clip is completely inserted through the pad and carrier.

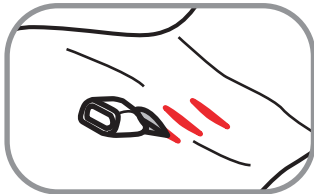

6. Check Buckle Position
Determine which of the available buckle positions will be comfortable and provide a snug fit for your child.

⚠ WARNING:
Failure to reinstall the harness system correctly can result in serious injury or death.

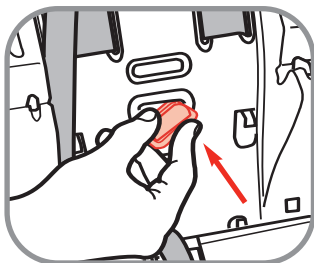

To Change Buckle Position
a. Remove child. From under the seat, insert buckle's metal retainer up through the carrier and pad.

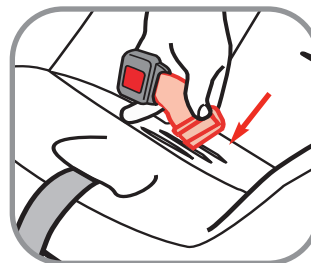

Buckle Placement for Small Infants
d. Choose the slot closest to the back of the restraint. Push metal clip through the pad and carrier. Make sure buckle is facing out.

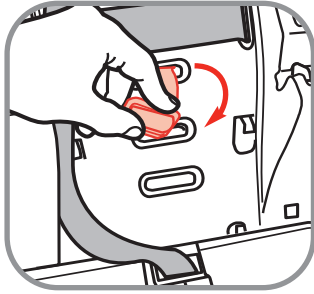

e. From the bottom, pull the metal clip through the carrier and insert it into the middle slot.

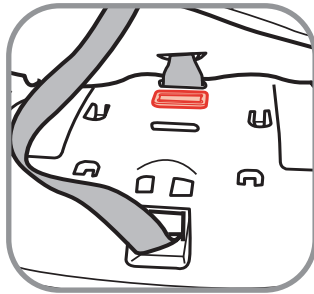

f. From the front, lift pad up and place the buckle's metal clip flush on bottom of the carrier. Replace the pad.

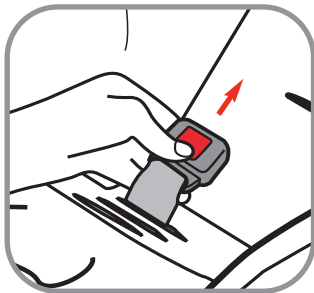

g. Pull on the buckle to check to make sure buckle's metal clip is secured.

⚠ WARNING:
Failure to reinstall the harness system correctly can result in serious injury or death.

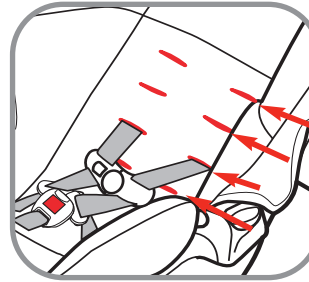

7. Check Harness Height

With child in the child restraint, check the location of the harness slot.

Follow the guidelines below to determine the correct harness/headrest height.

Rear-Facing Position

Harness slot must be **even with or just below** the shoulders.

If the bottom harness slots are above the child's shoulders, **do not** use this child restraint.

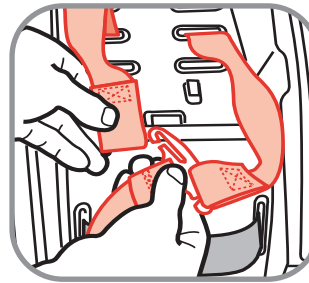

7. To Change Harness Location

With harness system loose, from the back, remove harness from the splitter plate.

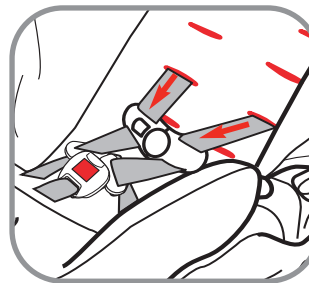

a. From the front of child restraint, pull harness straps out.

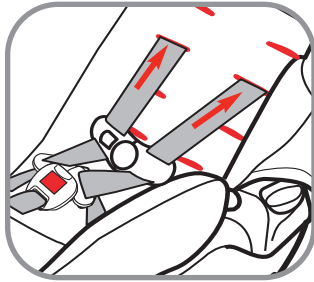

b. Rethread harness into new harness slot location. Make sure harness straps do not twist.

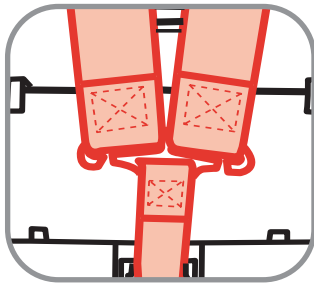

c. From the back of the child restraint, reattach the harness straps to the splitter plate.

NOTE: Make sure the harness straps and harness adjustment strap are not twisted.

⚠ WARNING:



Do not use this child restraint if the top of your child's head is within one inch from the top of the child restraint.

Make sure the harness height is correct for your child's size.

Make sure you have reinstalled the harness system correctly.

Failure to follow these steps can result in serious injury or death.

C-6 Securing Child in Child Restraint

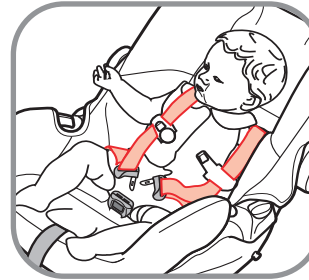

1. Position Harness Straps Over the Child's Shoulders.



2. Buckle Harness

Push each buckle tongue into buckle until you hear a "click". Remember to always pull up on harness straps to make sure buckle is locked.

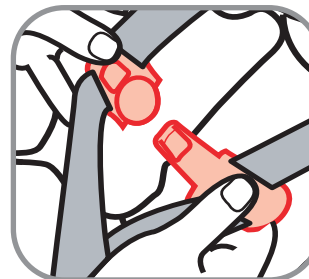

3. Close Chest Clip

Insert right half of chest clip into left half and snap together.

C. Basic Use

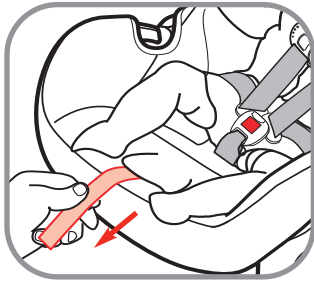

4. Tighten Harness

Pull on harness tightening strap to tighten harness snugly.

NOTE: A snug strap should not allow any slack. It lies in a relatively straight line without sagging. It does not press on the child's flesh or push the child's body into an unnatural position.

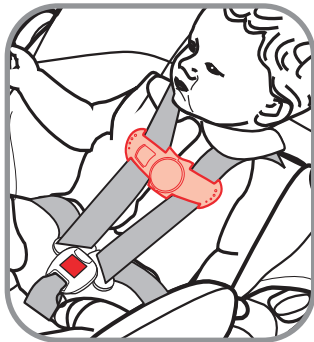

5. Position Chest Clip

The chest clip must be placed at mid-chest (even with armpits) and away from the child's neck.

⚠ WARNING:
Failure to fasten and tighten the harness system correctly and snugly can result in serious injury or death.

C-7 Removing Child From Child Restraint

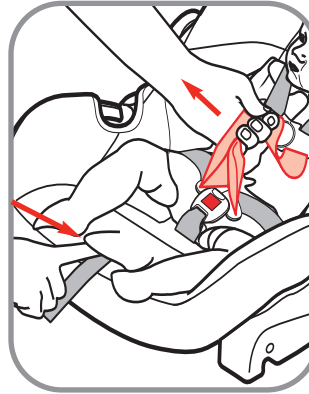

1. Loosen Harness

Press on harness release lever while pulling on both harness straps above the buckle to loosen.

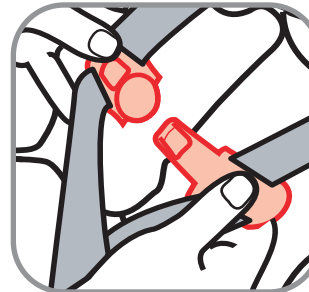

2. Release Chest Clip

Press on release button and pull apart.

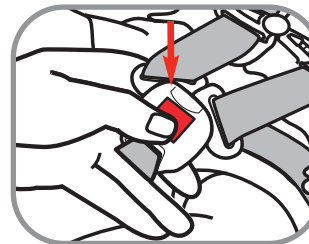

3. Unbuckle

Press red button on buckle to release the buckle tongues. Move harness away from child and remove child.

C. Basic Use

C-8 Removing Harness System



1. Remove Harness Straps from Splitter Plate

Fully loosen harness straps. Locate splitter plate on the back of the child restraint and unfasten the harness straps.

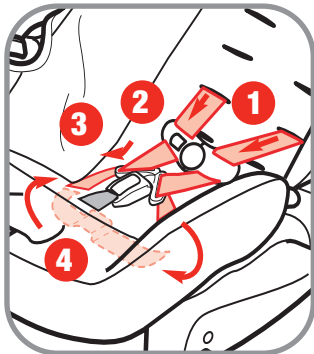

2. Remove Harness Straps

Pull harness through the slots from the front (1).

Unthread harness from the chest clip (2).

Unthread harness from the buckle tongues (3).

Pull harness out of plastic shell (4).

C-9 Removing Pad for Cleaning

You must remove the harness system to remove the pad from the plastic shell.

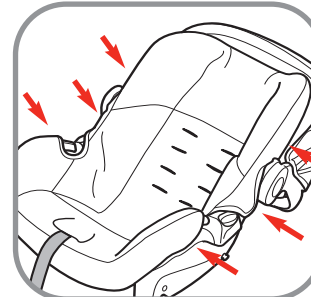

1. Release the Pad Tabs

To release the tab, pull down on the pad and pull the tab out of the carrier.

Depending on your model, unhook pad from the tabs at the top of the carrier (A).

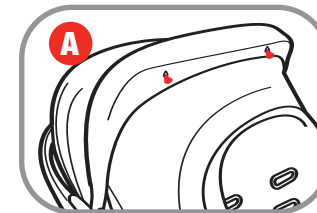
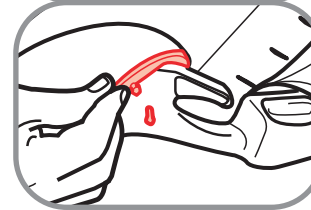

2. Remove Pad from Top and Bottom of Shell

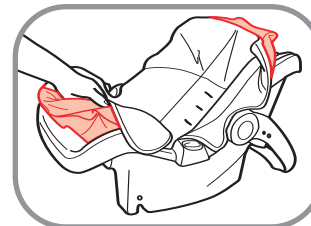

3. Pull Buckle Through Pad

Remove pad.



C. Basic Use

Cleaning Pad

Hand wash pad with warm sudsy water, rinse clean and air dry. Spot clean the harness straps. Do not use bleach or use other harsh cleaners. Do not dry clean or machine wash.

⚠ WARNING:
Do not use child restraint without the pad.

Replace child restraint pad by reversing order; Starting from top of the child restraint, slip pad on plastic shell; insert buckle and pull harness tightening strap through pad. Slip pad over front of the plastic shell.

Attach all of the plastic tabs on the sides of plastic shell.
 Rethread harness (see section C-12).

C-10 Canopy Use and Installation

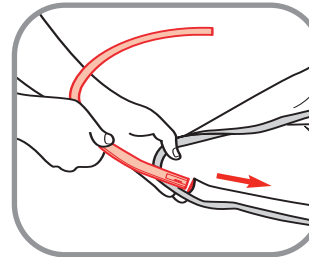

1. Thread Plastic Strip

Completely thread the plastic strip in the channel in front of the canopy.

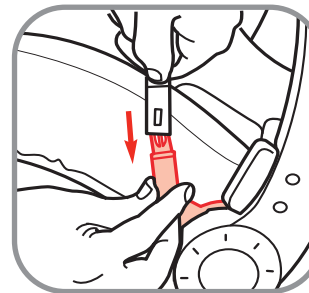

2. Attach Canopy to Carrier

Fit back of canopy over back of carrier. Snap each plastic strip end to each canopy post.

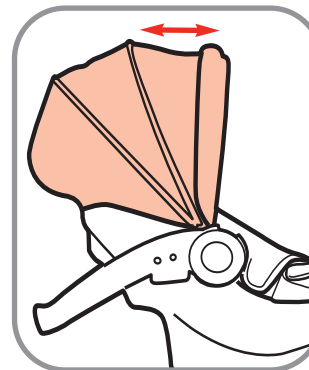

3. To Adjust Canopy

Grasp the front of the canopy and move front to back to desired location.

C. Basic Use

C-11 Infant Insert

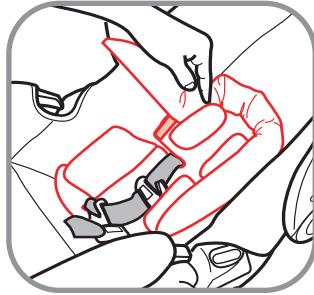

1. To Remove Head/Hip Roll

Undo the fastening strips and pull the infant insert out from behind the harness straps.

To Attach Head/Hip Roll:

Undo the fastening strips and fit the infant insert behind the harness straps. Refasten the fastening strips.

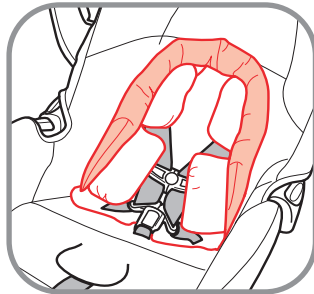

For Smaller Infants (on select models)

If your infant is small for its age, place the head roll on the outside of the pillows. This will provide a snug fit for your infant.

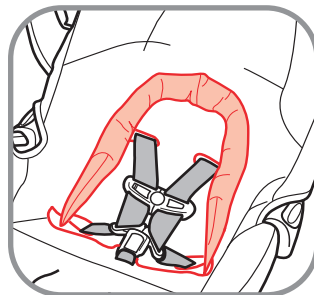

As your child grows, remove the pillows.

For larger infants, the infant insert can be removed altogether.

C-12 Installing Harness System

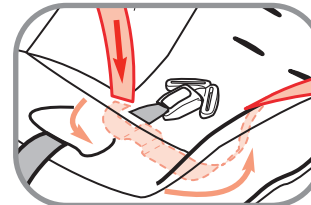

1. Thread the Harness Straps

Starting on the left side, insert harness in the harness slot, going through both pad and shell.

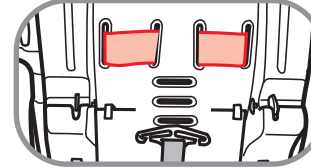

Make sure you weave the harness in and out of the shell, between shell and pad, as shown.

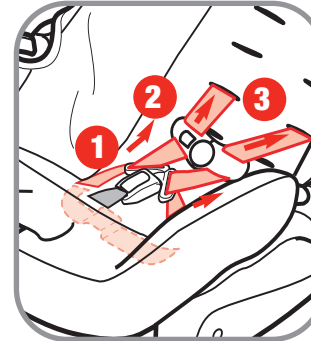

2. From the front, make harness ends even with each other.

Thread harness straps through each buckle tongue (1), thread through chest clip (2) and push harness ends through slots in the seat back (3). **Do not twist the harness.**

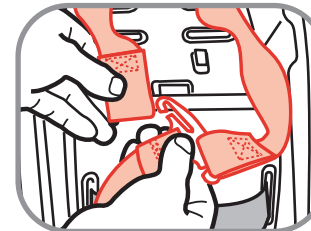

3. From the back of child restraint, attach harness straps to the splitter plate.

C. Basic Use

⚠ WARNING:

Failure to reinstall the harness system can result in serious injury or death.

D-1 Understanding Your Vehicle

Your vehicle's features may be considerably different than those pictured here. Consult your vehicle owner's manual to help identify your vehicle's specific features and locations.

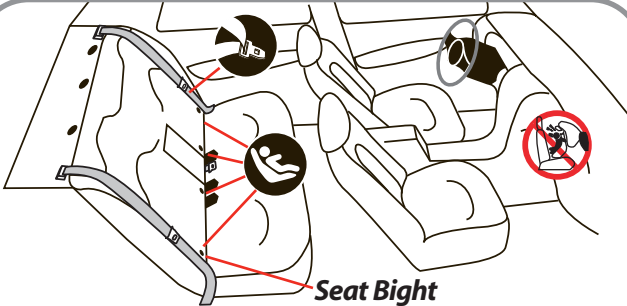

Seat Bight

 **Vehicle Seat Belts**
Consult your vehicle owner's manual for vehicle belt use.

 **Air Bags**
Consult your vehicle owner's manual for all air bag locations.

 **LATCH Anchors**
Located in the seat bight.

Safety Tip:

To help protect your vehicle seat's upholstery from damage, use a single layered towel underneath and behind child restraint.

To avoid your child being seriously burned, take the following precautions:

1. Park in the shade or where sun does not directly hit the child restraint.
2. Cover the child restraint with a sheet or blanket when not in use.
3. Check for hot child restraint and buckles before placing child in child restraint.

D-2 Vehicle Seating Position

Some seating positions in your vehicle may not be safe for this child restraint. Some vehicles do not have a seating position that can be used safely with this child restraint. If you are not sure where to place the child restraint in your vehicle, consult your vehicle owner's manual or contact Dorel Juvenile Group Consumer Relations Dept.

⚠ WARNING:



Never place a child rear-facing in a seating position with an active frontal airbag. This can result in serious injury or death.

⚠ WARNING:



Use the child restraint only on vehicle seats that face forward. Do not use on seats that face the sides or rear of the vehicle.



Safety Tip:



Children are safer when properly restrained in rear seating positions than in the front seating positions.

According to National Highway Traffic Safety Administration information, children in rear seating positions are statistically safer, whether you have air bags, advanced air bags, or no air bags at all.

D-3 Choosing LATCH or Vehicle Belts

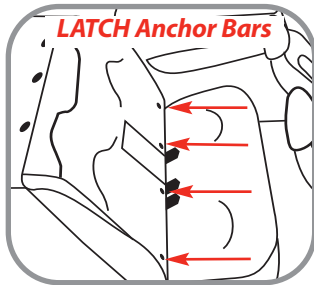

The LATCH System

LATCH (Lower Anchors and Tethers for CHildren) is a universal system for installing child restraints without using vehicle seat belts.

The LATCH system can ONLY be used in vehicles that have the LATCH anchor bars installed and designated LATCH seating positions. Most vehicles manufactured after September 2002 are equipped with LATCH.

Check your vehicle owner's manual to see which seating positions may be equipped with the LATCH system.

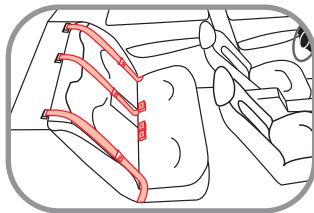

Vehicle Belts

If LATCH is not an option, you must use the vehicle seat belt system to install the child restraint. There are some vehicle belts that will not work with a child

restraint or will require special attention.

See next page and check your vehicle's owner's manual for specific instructions.

⚠ WARNING:
Do not use both the LATCH belt and vehicle belt at the same time.

D-4 Knowing Your Vehicle Belts

Review your vehicle's owner manual for vehicle seat belt use with child restraints. This is your best source for information concerning your vehicle.

Not all vehicle belts will work with this child restraint. This child restraint must be tightly locked in place at all times, during travel. You must determine if your vehicles belts are compatible with this child restraint.

Vehicle Belts

• Automatic/Passive vehicle seat belts

You MUST have a vehicle lap belt to install any child restraint. An automatic (passive) shoulder vehicle belt may or may not have a separate vehicle lap belt. Consult your vehicle owner's manual.



• Vehicle belts in center of the door or side panel

You must move the child restraint to another seating location. Consult your vehicle owner's manual.

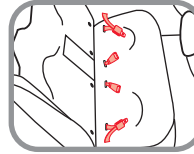

• Vehicle belts that are in front of the seat bight

You may need to move the child restraint to another seating location. Consult your vehicle owner's manual.

• ELR (Emergency Locking Retractor) vehicle belts

These lap and shoulder vehicle belts only lock in a sudden stop or crash, and do not properly secure a child restraint alone. Consult your vehicle owner's manual.

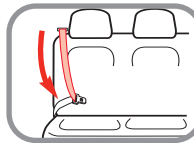

To learn if you have this type of vehicle belt, gently pull the vehicle belt all the way out of the retractor (spool), let it return several inches, then pull on it again. If it moves freely, it is an ELR vehicle belt. If it is locked and will not allow any more vehicle belt to come out, it is a switchable retractor.

⚠ WARNING:
ELR lap-only vehicle belts MUST NOT be used with this child restraint.

D. General Vehicle Installation

• **Switchable retractor**

These vehicle belts switch from ELR to ALR (Automatic Locking Retractor). You must have the vehicle belts in the locking mode to use them. Follow the instructions in the installation sections.

• **ALR (Automatic Locking Retractor)**

These vehicle belts lock after pulling the webbing out and letting the vehicle belt go back into the retractor an inch or two. Follow the instructions in the installation sections.

Vehicle Latch Plates

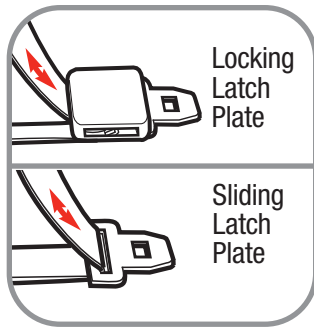

• **Check the Latch Plates on Your Lap and Shoulder Belt**

Grasp the tongue portion of the latch plate (the part that goes inside the buckle) and pull straight out, in line with the vehicle lap belt. If the latch plate does not slide up and down the vehicle belt, you have a locking latch plate. You should not need

to use a locking clip. Consult your vehicle owner's manual.

If the latch plate slides up and down on the vehicle belt, and you have an ELR retractor, you **MUST** use a locking clip to install the child restraint. You may not need to use the locking clip with a switchable or ALR retractor. Consult your vehicle owner's manual.

D-5 Using the Locking Clip

A locking clip will not fix all types of vehicle seat belt problems. Review section D-4 and your vehicle's owner manual for vehicle seat belt use with child restraints. The locking clip is located on the back of the child restraint.

⚠ WARNING:

Do not use both the LATCH belt and vehicle belt at the same time.

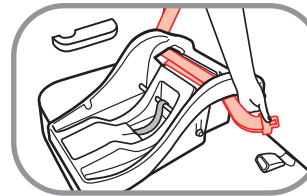

1. Place Base in Vehicle Rear-Facing

Thread vehicle lap belt through the belt path as shown. Buckle.

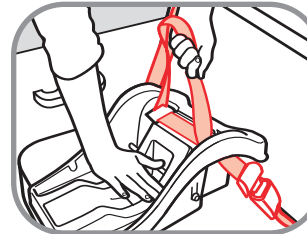

2. Tighten Vehicle Belt

Push down firmly on the base and pull up on the shoulder belt to tighten

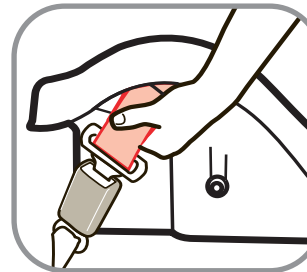

3. Locate Locking Clip Location

Grasp both vehicle belts together just behind the latch plate and unbuckle.

NOTE: If the latch plate ends up just at the belt path opening so you cannot grasp the vehicle belt at the latch plate, grasp the vehicle belts on the opposite side of the child restraint, as close to the latch plate as possible. Install the locking clip on the latch plate end, as close as possible.

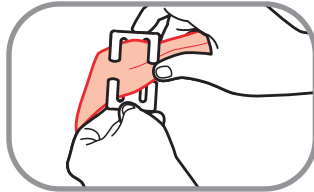

4. Attach Locking Clip

Thread both portions of the vehicle belt onto the locking clip, as close to the latch plate as possible.

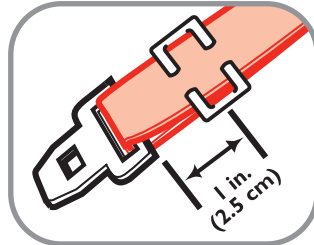

5. Position Locking Clip

Position locking clip about 1 in. (2.5 cm) from vehicle belt's latch plate. Rebuckle vehicle belt.

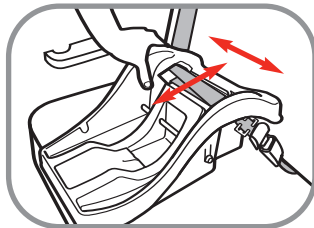

6. Check Vehicle Belt Tightness

Grasp the base at the vehicle belt path with one hand. Push and pull the base from side to side, forward and back. The base should not move more than 1 inch.

NOTE: If base moves more than 1 inch, redo all of the steps or try another seating location.

Remove the locking clip when the vehicle seat belt is not being used with a child restraint.

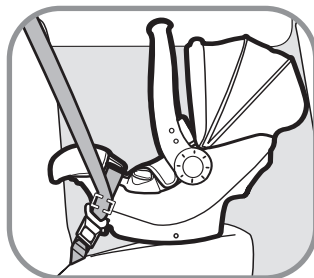

7. Same steps apply for use on the carrier. See section E-6 for step by step instructions

D-6 Installing on Aircraft



This restraint is certified for aircraft use.

Use only on forward-facing aircraft seats. Follow instructions for vehicle installation.

Contact the airline for their specific policies.

D-7 Storing LATCH System

⚠ WARNING:
Failure to securely store the LATCH system and completely close and lock the storage door can result in serious injury or death.

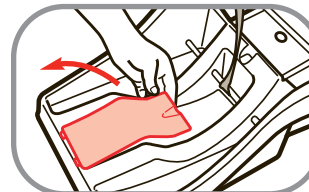

1. Open LATCH Storage Door

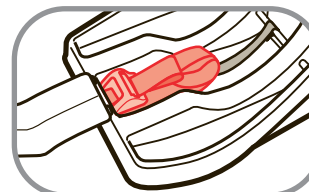

2. Store LATCH System

Fold in the LATCH hooks, adjuster and belt inside the storage area.



3. Completely Close and Lock Storage Door

Storage door **MUST** be closed and locked.

E-1 Rear-Facing Installation with Base



 LATCH Belt



 Lap/Shoulder Belt



 Lap Belt



⚠ WARNING:

Never place a child rear-facing in a seating position with an active frontal airbag. This can result in serious injury or death.

This child restraint must always face the rear of the vehicle when the child is between 4-35 lbs (1.8-15.9 kg) and is less than one year old.



E-2 Preparing to Install Base with LATCH

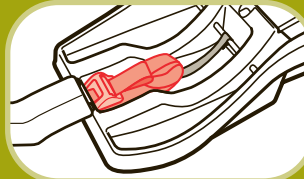

1. Remove LATCH from Storage

Open storage door and remove the LATCH system.

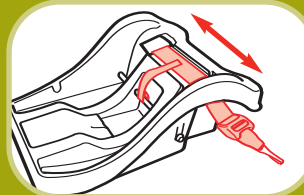

2. Thread LATCH Belt

Thread the LATCH belt through belt path as shown.



E-3 Installing Base with LATCH

See your vehicle owner's manual for information on designated LATCH positions and anchor locations.

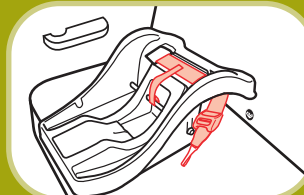

1. Place Base in Vehicle Rear-Facing

Center the base between the vehicle anchors in the chosen seating position.

⚠ WARNING:

Do not use the LATCH system along with the vehicle lap or lap/shoulder belt.

Check LATCH belt before each use. Use only if the belt can be tightened properly and securely.

Failure to follow these warnings can result in serious injury or death.

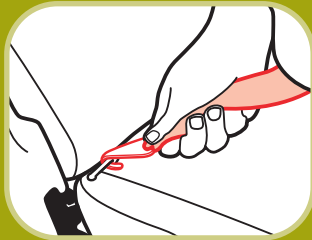

3. Hook LATCH to Vehicle LATCH Anchor

Fasten one LATCH belt hook to the anchor in the vehicle seat located in the vehicle seat bight. Repeat for other side of child restraint.



4. Tighten LATCH Belt

Push down firmly on the base and pull up on the free end of belt to tighten.



5. Check LATCH Belt Tightness

Grasp the base at the belt path with one hand. Push and pull the base from side to side, forward and back. The base should not move more than 1 inch.

NOTE: If base moves more than 1 inch, try reinstalling the base or try another seating location.

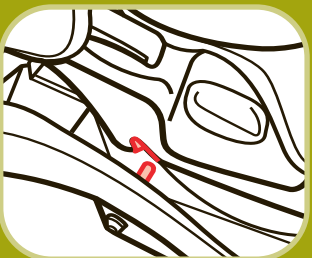

6. To Attach Carrier to Base

Align the notches in the front of carrier with the base lock bar. Push down firmly to lock. You will hear a "click" when it is locked. Pull up on carrier to make sure it is locked.

⚠ WARNING:

Failure to securely attach carrier to base can result in serious injury or death.

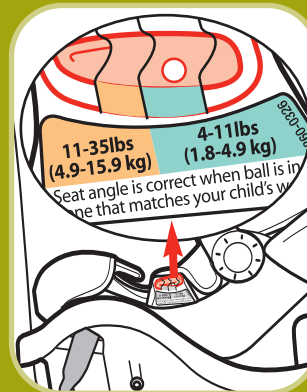

7. Check for Proper Recline

Check the angle indicator. The ball should be between the two marks on the indicator that matches the weight of your child. Adjust base if needed. (see section C-2 or read below).

NOTE: Check the angle indicator while parked on level ground.

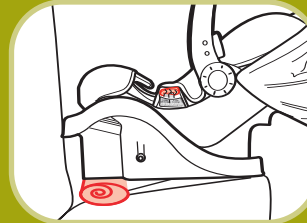

You may need to place a large rolled towel(s) or foam pool noodle(s) under the front of the base to achieve correct recline angle. Check often to be sure padding is still in place and the belt is tight.

DO NOT add a towel or pool noodle while the optional footrest is being used.



8. To Remove LATCH Belt From Vehicle Anchor

Remove carrier from base. Press down firmly on the base on the side with the LATCH adjuster. Press release button to release tension. Unhook LATCH from bar by squeezing spring lever and twist hook.



E-4 Installing Base with Vehicle Belts

⚠ WARNING:

Do not use the LATCH system along with the vehicle lap or lap/shoulder belt. Store LATCH belts when using the vehicle belts.

Check the vehicle belt before each use. Use only if the belt is tightened properly and securely.

Failure to follow these warnings can result in serious injury or death.

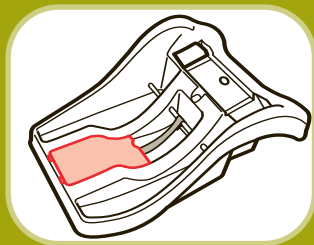

1. Store LATCH Belts

You **MUST** store the LATCH system when using the vehicle seat belts. See section D-7.

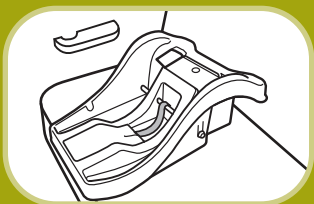

2. Place Base in Vehicle Rear-Facing

Center the base in the chosen seating position.



3. Thread Vehicle Belt

Thread the vehicle lap or lap/shoulder belt combination through belt path as shown.

With an ALR belt, pull the belt all the way out before threading the base.

43



5. Tighten Vehicle Belt

Push down firmly on the base and pull up on the shoulder belt to tighten

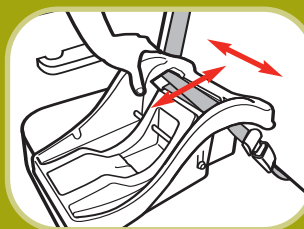

6. Check Vehicle Belt Tightness

Grasp the base at the **belt path** with one hand. Push and pull the base from side to side, forward and back. The base should not move more than 1 inch.

NOTE: If base moves more than 1 inch, try reinstalling the base or try another seating location.

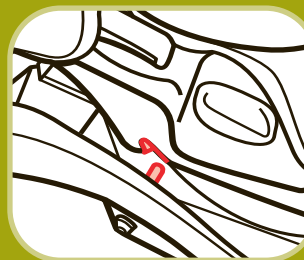

7. To Attach Carrier to Base

Align the notches in the front of carrier with the base lock bar. Push down firmly to lock. You will hear a "click" when it is locked. Pull up on carrier to make sure it is locked.

⚠ WARNING:

Failure to securely attach carrier to base can result in serious injury or death.

44

continued on next page.

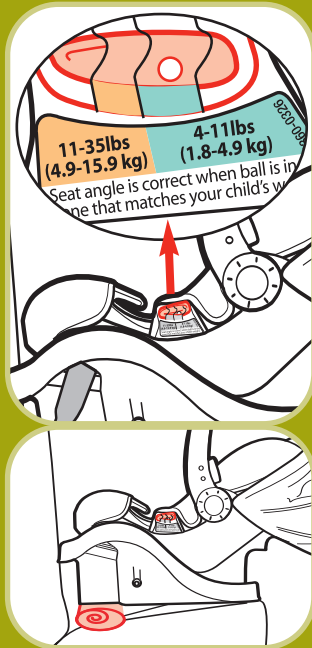

8. Check for Proper Recline

Check the angle indicator. The ball should be between the two marks on the indicator that matches the weight of your child. Adjust base if needed. (see section C-2 or read below).

NOTE: Check the angle indicator while parked on level ground.

You may need to place a large rolled towel(s) or foam pool noodle(s) under the front of the base to achieve correct recline angle. Check often to be sure padding is still in place and the belt is tight.

DO NOT add a towel or pool noodle while the optional footrest is being used.

E-5 Rear-Facing Installation without Base

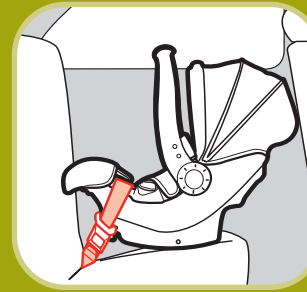

Lap Belt

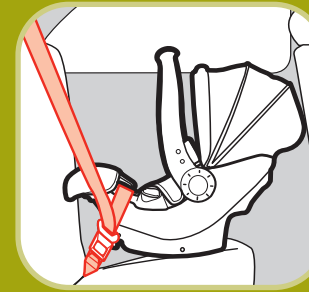

Lap/Shoulder Belt

E. Installing Rear-Facing

⚠ WARNING:



Never place a child rear-facing in a seating position with an active frontal airbag. This can result in serious injury or death.

This child restraint must always face the rear of the vehicle when the child is between 4-35 lbs (1.8-15.9 kg) and is less than one year old.

Do not use the LATCH system along with the vehicle lap or lap/shoulder belt. Store LATCH belts when using the vehicle belts.

Check the vehicle belt before each use. Use only if the belt is tightened properly and securely.

Failure to follow these warnings can result in serious injury or death.



E-6 Installing Carrier with Vehicle Belts

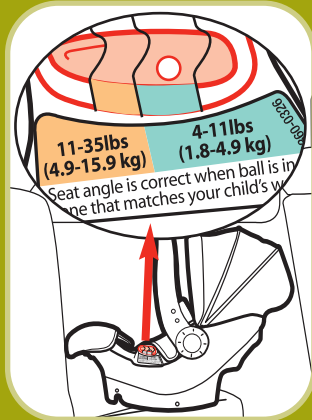

1. Place Child Restraint in Vehicle Rear-Facing

Center the base in the chosen seating position. Check the angle indicator. The ball should be between the two marks on the indicator that matches the weight of your child.

NOTE: Check the angle indicator while parked on level ground.

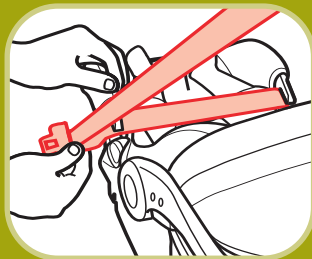

2. Thread Vehicle Belt

Thread vehicle lap belt through the belt path (as shown). Buckle the vehicle belt.

With an ALR belt, pull the belt all the way out before threading.



3. Tighten Vehicle Belt

Lay your forearm across child restraint at the belt path while pulling up on belt to tighten. Feed the slack back into the retractor while tightening.

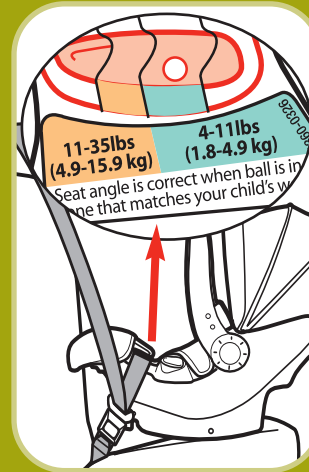

4. Check the Angle Indicator

The ball should be between the two marks on the indicator that matches the weight of your child.

NOTE: Check the angle indicator while parked on level ground.

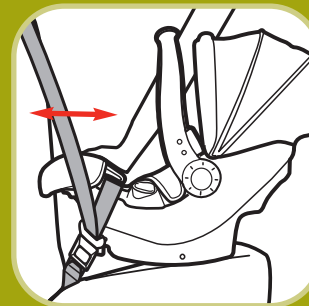

5. Check Vehicle Belt Tightness

Grasp the child restraint at the belt path with one hand. Push and pull the child restraint from side to side, forward and back. The child restraint should not move more than 1 inch.

NOTE: If carrier moves more than 1 inch, try reinstalling the base or try another seating location.

E. Installing Rear-Facing

Warranty

Dorel Juvenile Group, Inc. (DJG) warrants this product to the original retail purchaser as follows:

This product is warranted against defective materials or workmanship for one year from the date of original purchase. **An original receipt is required to validate your warranty.** DJG will, at its option, provide replacement parts or replace this product. DJG reserves the right to substitute if the part or model has been discontinued.

To make a claim under this warranty you may contact us at www.djgusa.com, fax us at 1-800-207-8182 24 hours a day, write to DJG, Consumer Relations Department, P. O. Box 2609, Columbus, IN 47202-2609, or call 1-800-544-1108 from 7:00 a.m. to 6:00 p.m. EST Monday through Thursday and from 7:00 a.m. to 4:30 p.m. on Friday. **Proof of purchase is required and shipping charges are the responsibility of the consumer.**

Warranty Limitations:

This warranty does not include damages which arise from misuse or abuse of this product.

Limitation of Damages:

The warranty and remedies as set forth are exclusive and in lieu of all others, oral or written, expressed or implied. In no event will DJG or the dealer selling this product be liable to you for any damages, including incidental or consequential damages, arising out of the use or inability to use this product.

Limitation of warranties and other warranty terms and state law rights:

Any implied warranties, including implied warranties of the merchantability and fitness for a particular purpose, shall be limited to the duration and terms of the express written warranty. Some states do not allow limitations as to how long an implied warranty lasts or the exclusion or limitation of incidental or consequential damages, so the above limitations may not apply to you. This warranty gives you specific legal rights, and you may have other rights, which vary from state to state. Neither DJG nor the dealer selling this product authorized any person to create for it any other warranty, obligation, or liability in connection with this product. PLEASE COMPLETE AND MAIL THE PRE-ADDRESSED OWNER REGISTRATION CARD WITHIN (30) DAYS OF PURCHASE TO EXPEDITE WARRANTY CLAIMS AND TO VERIFY THE ORIGINAL DATE OF PURCHASE.

Replacement Parts Order Form

Complete the form below. Your model number with color code and manufacturer date code **MUST** be included on the form to ensure proper replacement parts. Your model number with color code and the date code can be found on a sticker on the side of child restraint. Payment in U.S. dollars must accompany your order. Choose parts needed from the list on the next page.

Return the form with payment to:

Dorel Juvenile Group, Inc.
Consumer Relations Department
P.O. Box 2609
Columbus, IN 47202-2609

Fax orders to: 1-800-207-8182

Please make money orders payable to Dorel Juvenile Group, Inc. Fill in the area below to charge to Visa or Mastercard. We do not accept personal checks or Discover Card. All outside of U.S. and Canada **MUST** use credit card.

Ship To (Please Print): _____

Name: _____

Address: _____

City: _____

State/Province: _____ Zip _____

Telephone: _____

Email Address: _____

We **MUST have this information
to process your order:**
Model Number (8 or 9 characters): _____
Manufacture Date (mm/dd/yyyy): _____

Replacement Parts List

NOTE: If requested color is not available, similar color will be substituted.

| Part | Cost | Quantity | Total Cost |
|---------------------------|---------|----------|------------|
| Buckle Strap/Buckle . . . | \$6.99 | X _____ | = \$ _____ |
| Harness Strap | \$2.00 | X _____ | = \$ _____ |
| Pad Set | \$27.50 | X _____ | = \$ _____ |
| Chest Clip | \$1.50 | X _____ | = \$ _____ |
| Locking Clip | \$2.50 | X _____ | = \$ _____ |
| Latch Kit | \$24.99 | X _____ | = \$ _____ |
| Base | \$34.99 | X _____ | = \$ _____ |
| Instructions | \$0.00 | X _____ | = \$ _____ |

Merchandise Total \$ _____

Shipping and handling: \$ _____

| | | | |
|-------------------------------|--------|--------------------------------|---------|
| Up to \$25.00 | \$5.95 | \$100.01 to \$150.00 | \$10.95 |
| \$25.01 to \$50.00 | \$6.95 | \$150.01 to \$200.00 | \$11.95 |
| \$50.01 to \$75.00 | \$8.95 | \$200.01 and up | \$13.95 |
| \$75.01 to \$100.00 | \$9.95 | Outside Continental USA | \$10.00 |

Sales Tax \$ _____
 (Arizona, California, Georgia, Indiana, Missouri, South Carolina, and Texas residents add applicable sales tax.)

Grand Total \$ _____

No shipping and handling on instructions for quantities under 6. Add \$.50 for each instruction over 6, then add applicable shipping and handling.

CUT ON DOTTED LINE

Fill Out For Credit Card

Visa Mastercard

Card Exp. Date: _____

Cardholder's Name: _____

Card Number: _____

Signature _____