

# NOBLE Cot Instructions

NZ-NOB1565: 5,6,7

NZ-NOB1665: 1,2,14

NZ-NOB1765: 3,4,8,9,10,11,12,13,15

IMPORTANT. RETAIN FOR FUTURE REFERENCE.  
READ CAREFULLY

30 min. ▶

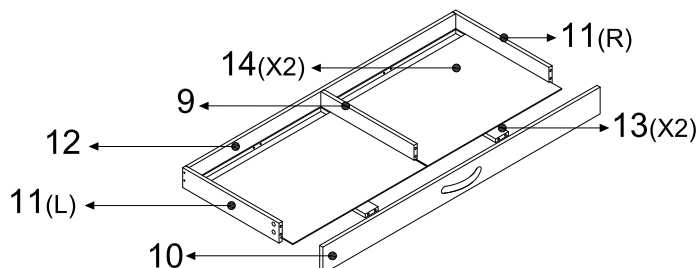
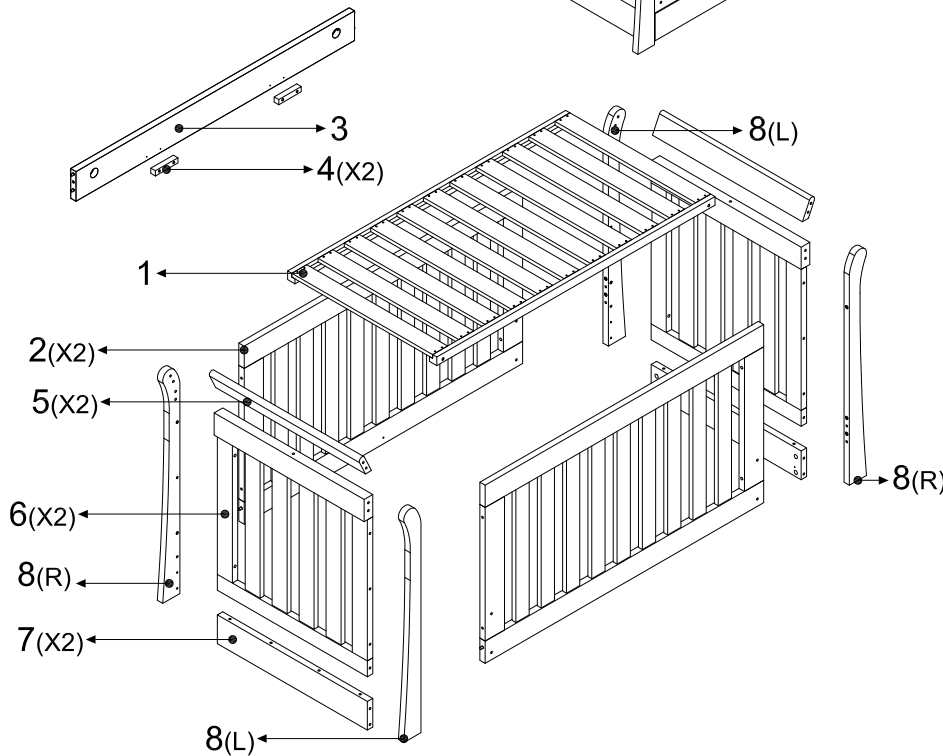
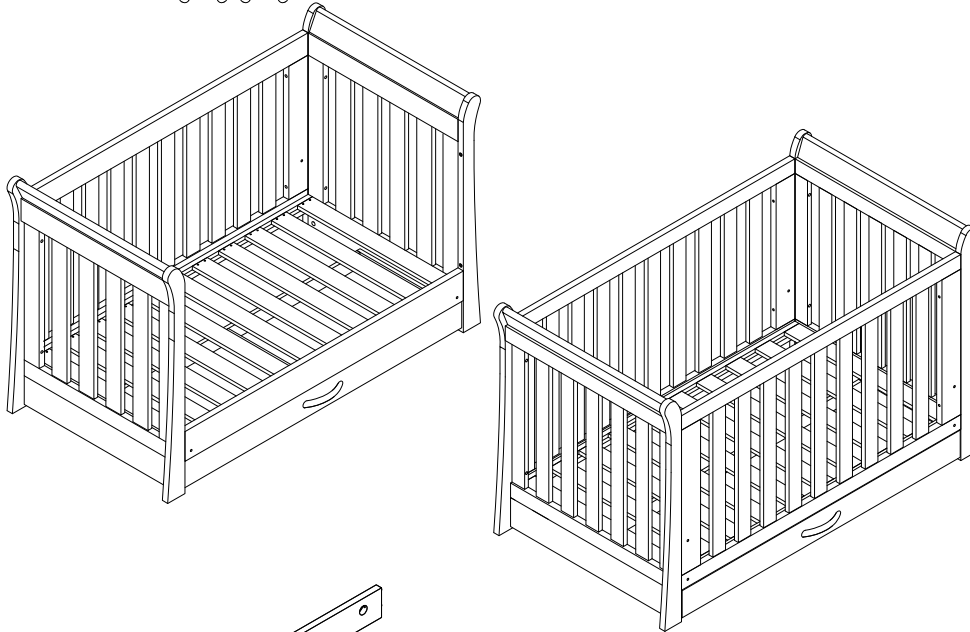
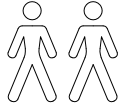

15

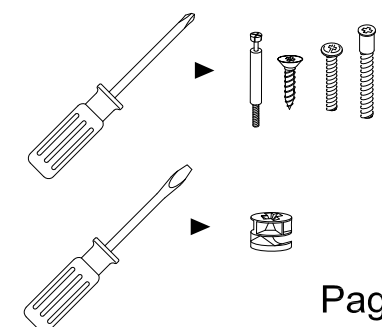
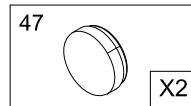
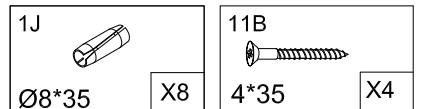
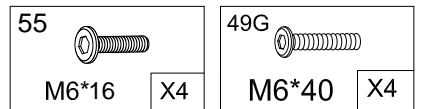
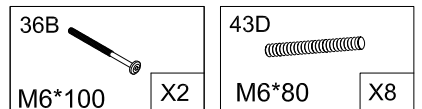
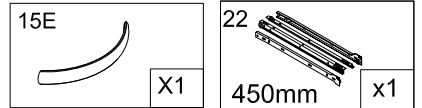
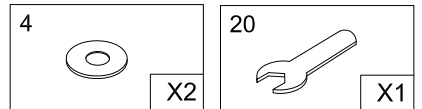
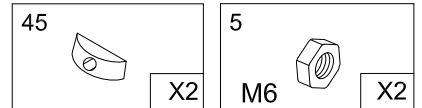
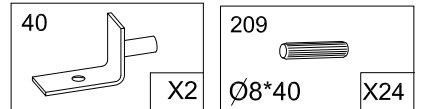
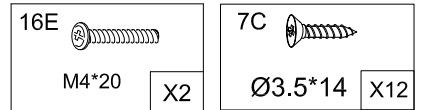
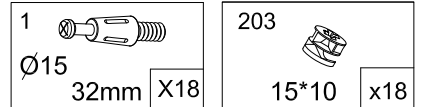
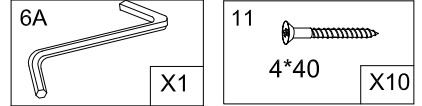
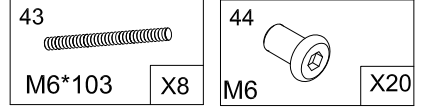

# **WARNING**

Safety guidelines and instructions must always be followed before making use of this product, please retain these instructions for future reference.

This product complies with product standard:

AS/NZS 2172:2013 Cots for household use - Safety Requirements & Trade Practices Act 1974-Consumer Protection Notice No.6 of 2005.

This cot has been designed for a child up to 25kg.

**RECOMMENDED MATTRESS SIZE:** This cot has been manufactured for use with a mattress which measures 690mm wide by 1300mm long and 130mm in thickness.

The width and length are specific because it is important that the gaps between the mattress and the sides and ends of the cot will not exceed 40mm. This is to minimize the risk of a child's limb becoming caught in the gap. The thickness of the mattress has been specified to ensure that the depth of the cot is greater than 500mm with the mattress base in the lower position to minimise the risk of a child climbing or falling out of the cot.

**WARNING TO PREVENT FALLS, THE MATTRESS BASE OF THIS COT SHOULD BE ADJUSTED TO THE LOWEST POSITION BEFORE THE CHILD CAN SIT UP.**

The manufacturer's assembly instructions must be followed in detail to ensure all the safety features of the cot are not compromised.

Please ensure that the cot is placed at a reasonable distance from curtains, blinds, heaters and power points.

Please keep medication, string, elastic, small toys or small items, such as money out of reach from any position in the cot.

**WARNING: TO PREVENT FALLS, THE MAXIMUM MATTRESS THICKNESS SHOULD NOT EXCEED 130mm.**

The highest mattress base position is the safest position for newborns. You should use this position until the child is able to sit up unassisted. Then the lowest base position should be used.

Regularly check that nuts, bolts and fittings are tightened properly. Loose fittings should be retightened as necessary. Loose fittings can result in snagging clothes or cords posing a risk of strangulation.

This cot bed is intended for use for children from birth to approximately 4 years of age. Use the cot for children from 0 - 18 months; use the toddler bed from 18 months to 4 years.

Children are likely to play, bounce, jump and climb on beds, therefore the child's bed should not be placed too close to other furniture or windows, and should be either tight to the wall or have a gap of 300mm between the wall and the side of the bed.

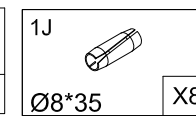
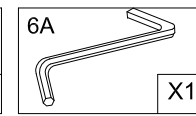
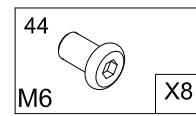
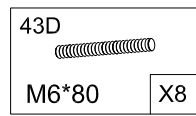
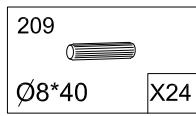
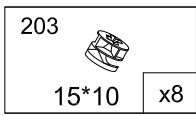
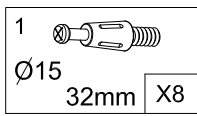

- 5(X2)
- 6(X2)
- 7(X2)
- 8(L)(X2)
- 8(R)(X2)

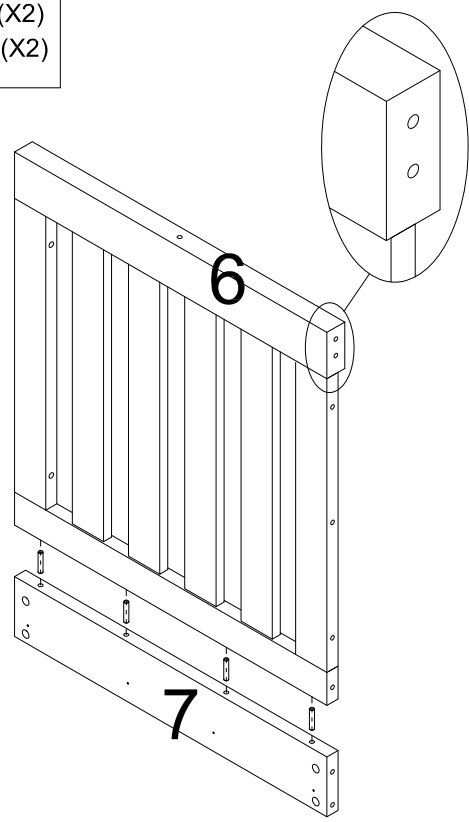

**STEP 1**

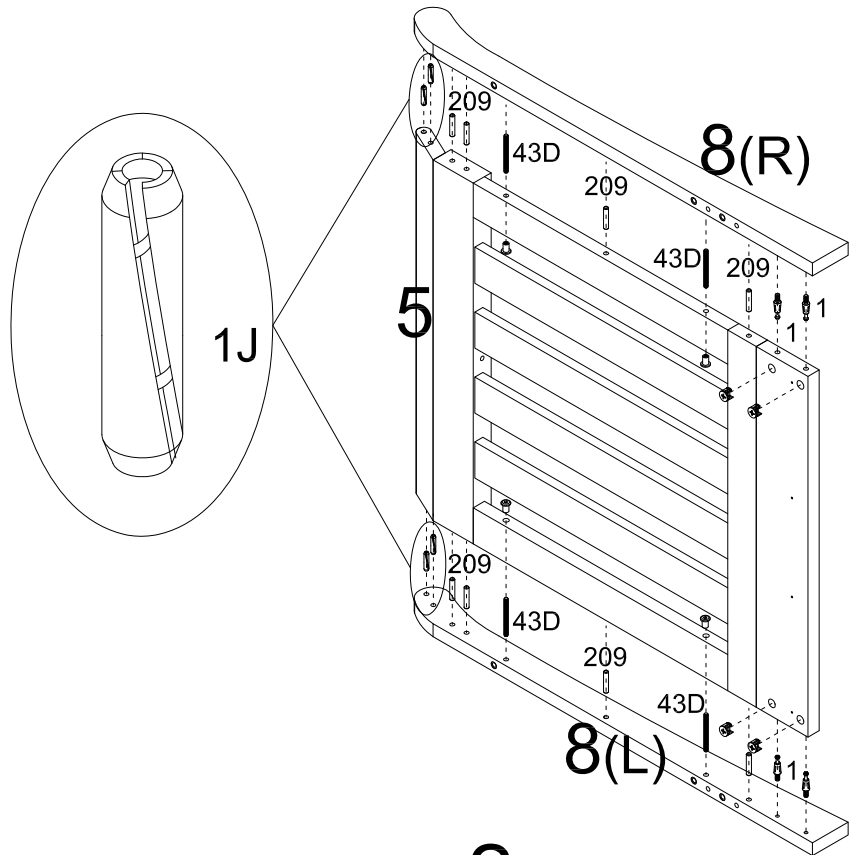

**STEP 2**

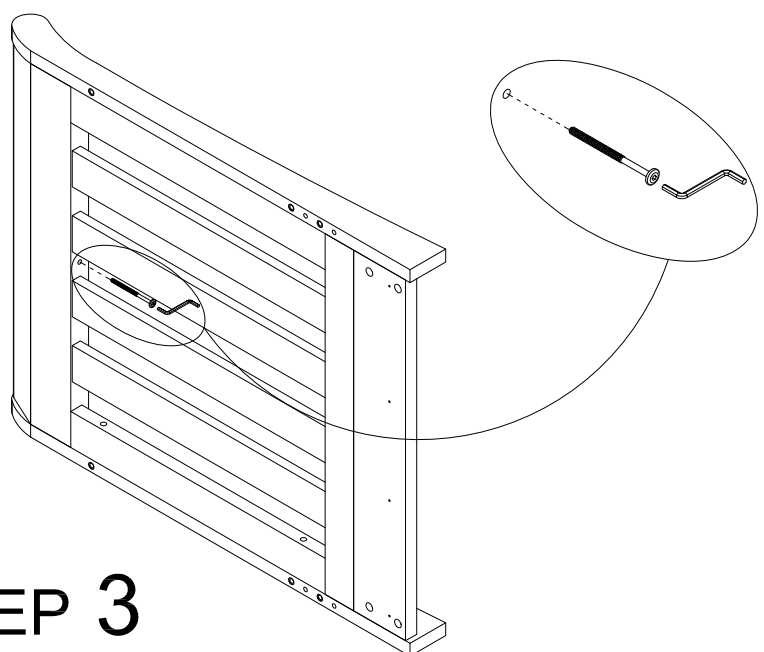
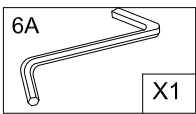
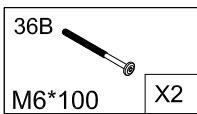
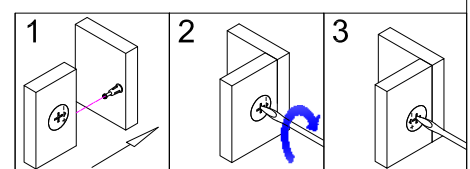

**STEP 3**

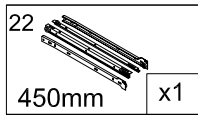
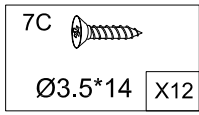

11(L)  
11(R)

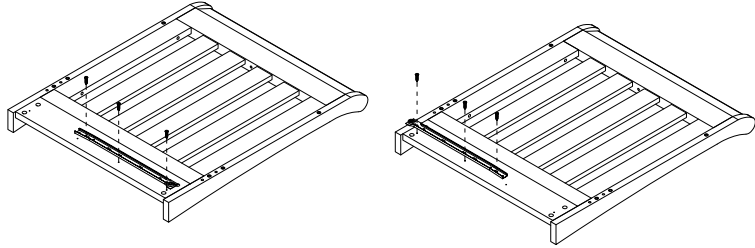
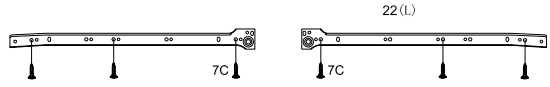
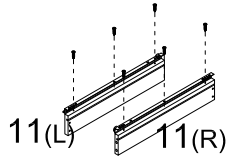

# STEP 4

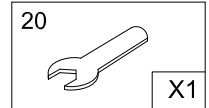
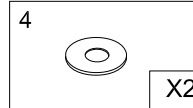
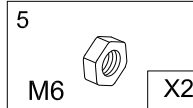
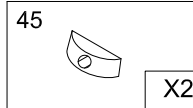
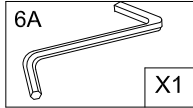
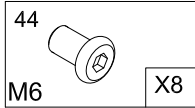
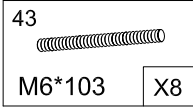

2(x2)  
3

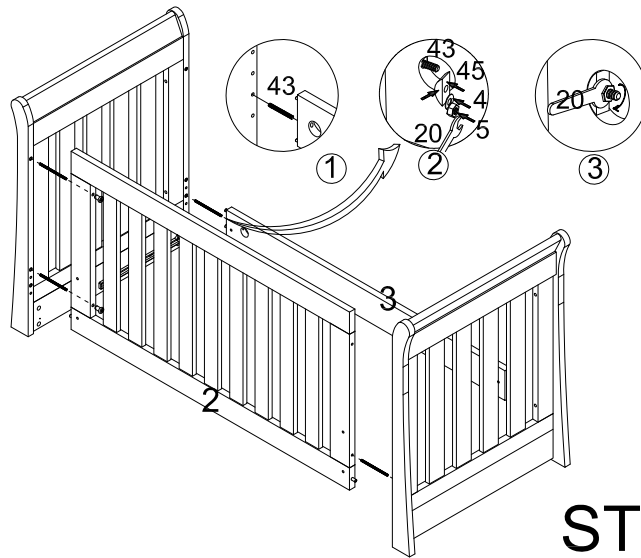

# STEP (5)

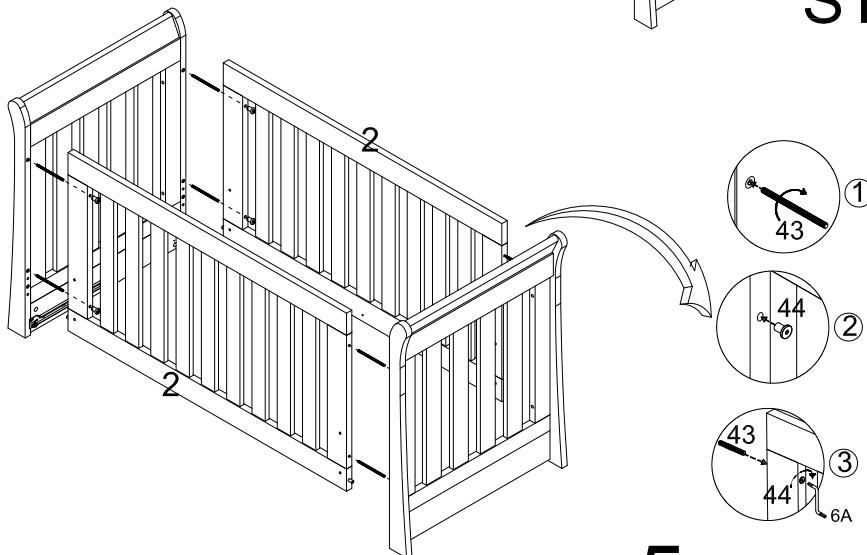

# STEP 5

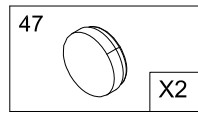
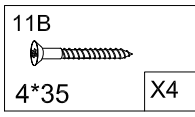
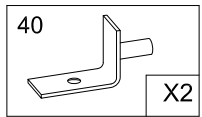
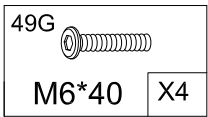
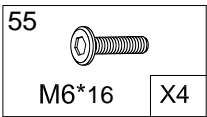

1  
4(X2)

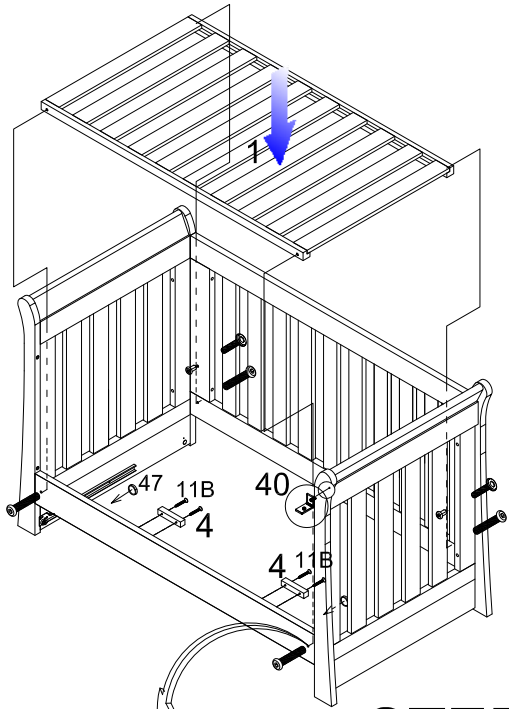

STEP (6)

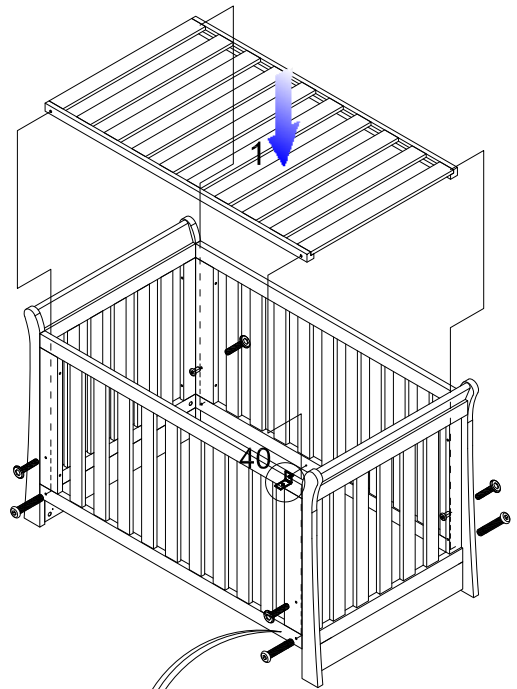
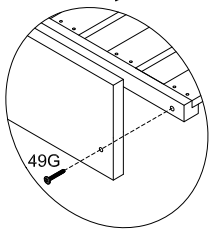

STEP 6

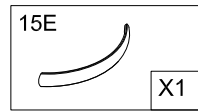
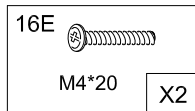
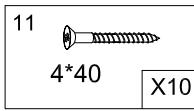
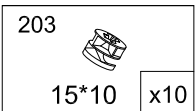
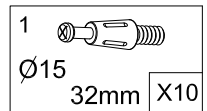
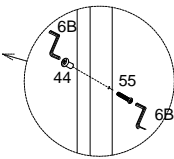
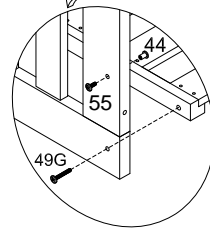

9  
10  
11(L)  
11(R)  
12  
13(X2)  
14(X2)

STEP 7

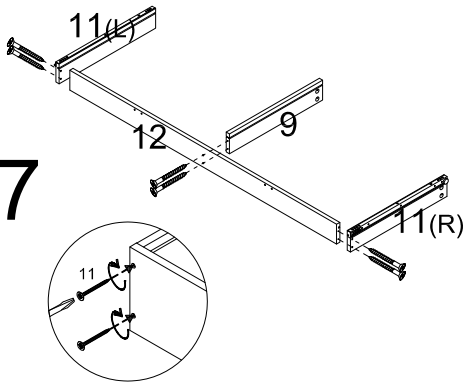

STEP 8

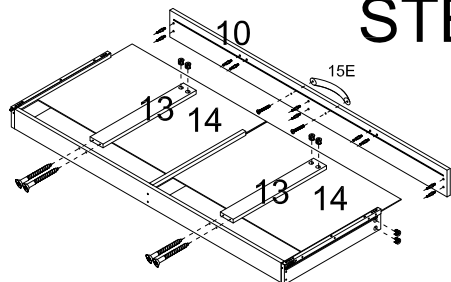

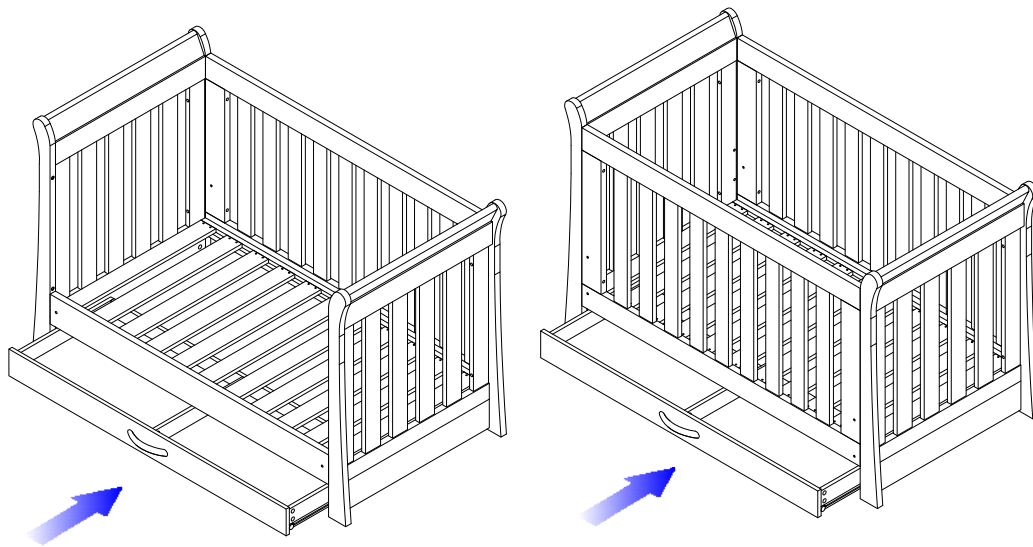

**STEP 9**

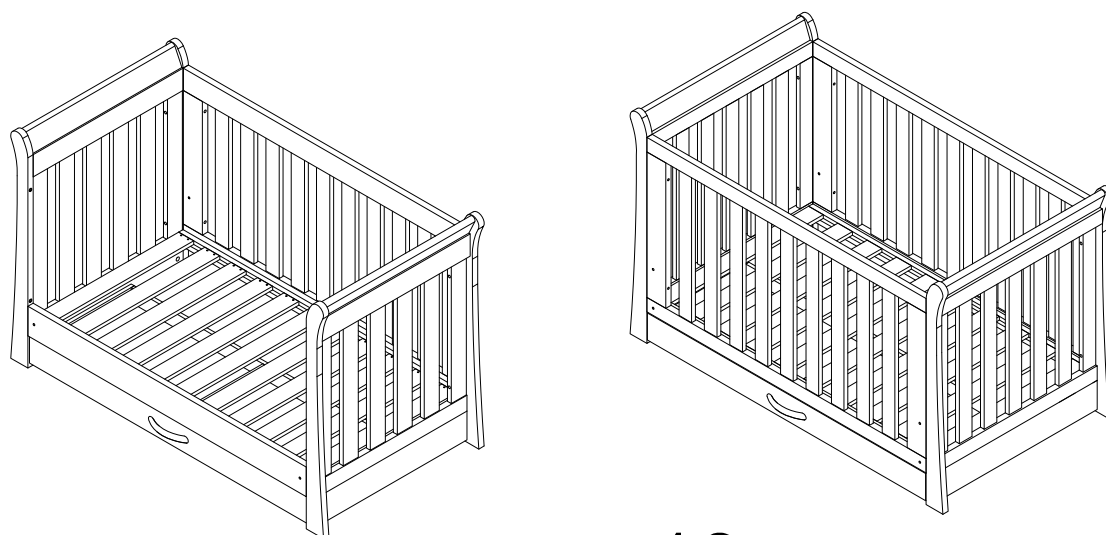

**STEP 10**

**Distributed by:**  
Baby Factory (NZ) LTD  
58 Stonedon Drive  
East Tamaki  
Auckland 2013  
New Zealand

***The Baby Factory***

[www.babyfactory.co.nz](http://www.babyfactory.co.nz)